

MODEL # 900308

3 IN 1 COMBO TABLE











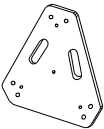
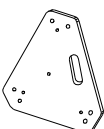
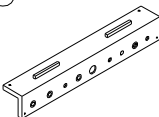
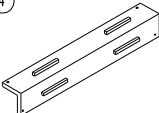
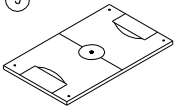
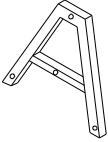

INSTRUCTIONS

 **WARNING:** Choking Hazard--Toy contains small balls and/or small parts. Not for children under 3 years.

IMPORTANT!



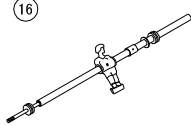
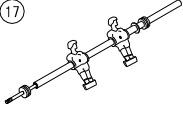
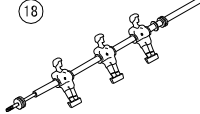
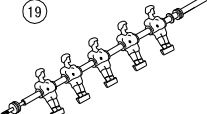
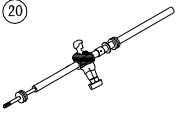
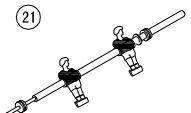
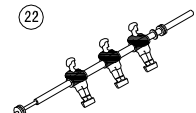
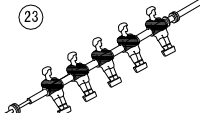









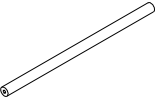
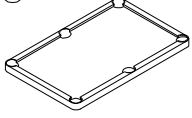

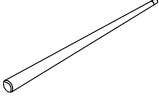

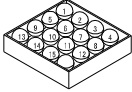
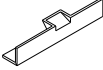
Please Keep Your Instructions. Before attempting assembly, please read through this instruction book to familiarize yourself with all the parts and assembly steps. We recommend that two adults assemble this game. Please refer to the Parts List below and be sure that all parts have been included.

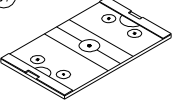
PARTS LIST

| | | | | |
|--|--|--|--|---|
| <p>①</p>  <p>END APRON 1EA</p> | <p>②</p>  <p>END APRON 1EA</p> | <p>③</p>  <p>SIDE APRON 2EA</p> | <p>④</p>  <p>SIDE APRON 1EA</p> | <p>⑤</p>  <p>SOCCER PLAYFIELD 1EA</p> |
| <p>⑥</p>  <p>STEEL LEG 2EA</p> | <p>⑦</p>  <p>8X50MM LEG BOLT 2EA</p> | <p>⑧</p>  <p>3. 5X28MM WASHER HEAD SCREW 12EA</p> | <p>⑨</p>  <p>3. 5X12MM WASHER HEAD SCREW 12EA</p> | <p>⑩</p>  <p>ALLEN WRENCH 1EA</p> |
| <p>⑪</p>  <p>PLAYER ROD BOLT 8EA</p> | <p>⑫</p>  <p>6X30MM LEG BOLT 20EA</p> | <p>⑬</p>  <p>22X8. 5MM WASHER 4EA</p> | <p>⑭</p>  <p>18X6. 5MM WASHER 24EA</p> | <p>⑮</p>  <p>3. 5X12MM FLAT HEAD SCREW 8EA</p> |
| <p>⑯</p>  <p>1 PLAYER ROD ASSEMBLY BLUE 1EA</p> | <p>⑰</p>  <p>2 PLAYER ROD ASSEMBLY BLUE 1EA</p> | <p>⑱</p>  <p>3 PLAYER ROD ASSEMBLY BLUE 1EA</p> | <p>⑲</p>  <p>5 PLAYER ROD ASSEMBLY BLUE 1EA</p> | <p>⑳</p>  <p>1 PLAYER ROD ASSEMBLY RED 1EA</p> |
| <p>㉑</p>  <p>2 PLAYER ROD ASSEMBLY RED 1EA</p> | <p>㉒</p>  <p>3 PLAYER ROD ASSEMBLY RED 1EA</p> | <p>㉓</p>  <p>5 PLAYER ROD ASSEMBLY RED 1EA</p> | <p>㉔</p>  <p>SOCCER BALL 2EA</p> | <p>㉕</p>  <p>HAND GRIP 8EA</p> |

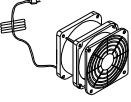
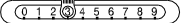
Warning! Take care about the cut and pinching hazards when changing the games.

PARTS LIST

| | | | | |
|--|---|--|--|---|
| <p>26</p>  <p>CORNER POCKET CAP 4EA</p> | <p>27</p>  <p>SIDE POCKET CAP 2EA</p> | <p>28</p>  <p>NET POCKET 6EA</p> | <p>29</p>  <p>STEEL ROD 2EA</p> | <p>30</p>  <p>BILLIARD PLAYFIELD 1EA</p> |
| <p>31</p>  <p>TRIANGLE 1EA</p> | <p>32</p>  <p>CUE STICK 2EA</p> | <p>33</p>  <p>CHALK 2EA</p> | <p>34</p>  <p>BILLIARD BALLS 1SET</p> | <p>35</p>  <p>GOAL END BOARD 2EA</p> |
| <p>36</p>  <p>GOAL BOX 3EA</p> | <p>37</p>  <p>HOCKEY PLAYFIELD 1EA</p> | <p>38</p>  <p>STOP CLIP 8EA</p> | <p>39</p>  <p>LEG BOLT 2EA</p> | <p>40</p>  <p>HOCKEY PUSHER 2EA</p> |
| <p>41</p>  <p>HOCKEY PUCK 2EA</p> | <p>42</p>  <p>MOTOR 1EA</p> | <p>43</p>  <p>SCORER 4EA</p> | <p>44</p>  <p>6X40MM WING BOLT 2EA</p> | <p>45</p>  <p>COPPER CAP 2EA</p> |
| <p>46</p>  <p>PLAYFIELD CAP 4EA</p> | | | | |

ASSEMBLY INSTRUCTIONS:

We recommend that two adults work together to assemble this game.

- 1) Open the carton of your new table game near where you will play. Select a clear level floor. This game requires at least two adults to assemble the table.
- 2) Remove all the contents from inside the carton and verify that you have all listed parts as shown on the Parts List. NOTE: The player rods are pre-assembled. We suggest that you use the bottom carton as a clean flat working area to protect the game. Carefully cut or tear the four carton corners so that the bottom is now your work area.

FIG. 1.

- 3) Place two Side Aprons (#3) and two Goal End Boards (#35) according to FIG. 1. Attach them using two of Leg Bolts (#12) and two of Washers (#14) per Goal End Board.

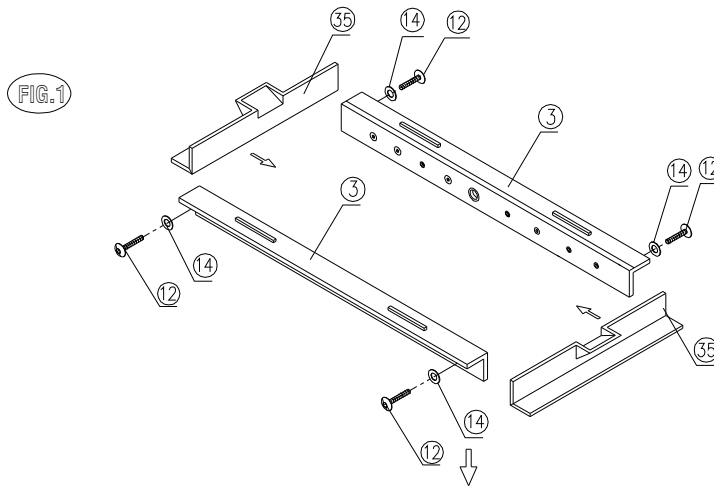

FIG. 2.

- 4) Attach Soccer Playfield (#5) with graphics facing down to Side Aprons using four of Washer Head Screws (#8) as shown in FIG. 2.

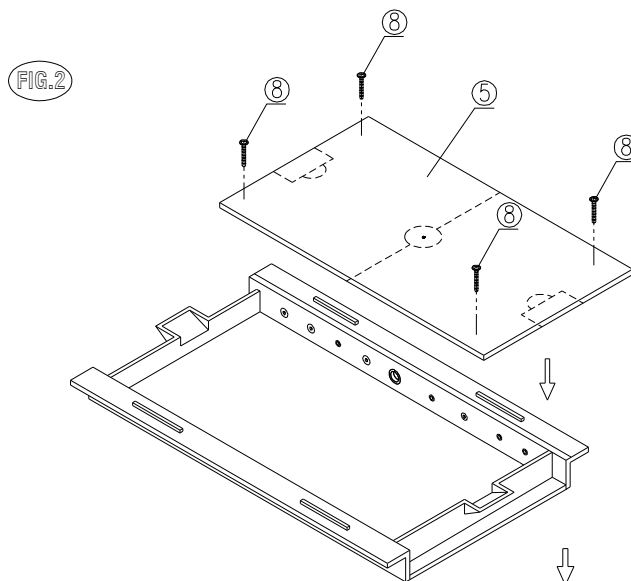

FIG.3.

- 5) Locate Side Apron (#4) and End Aprons (#1 and #2) as shown in FIG.3.
- 6) Attach Side Aprons (#3 and #4) to End Aprons (#1 and #2) using four of Leg Bolts (#12) per side apron. See FIG.3.
- 7) Attach Goal Boxes (#36) to End Aprons using four of Washer Head Screws (#9) per goal box see FIG.3.

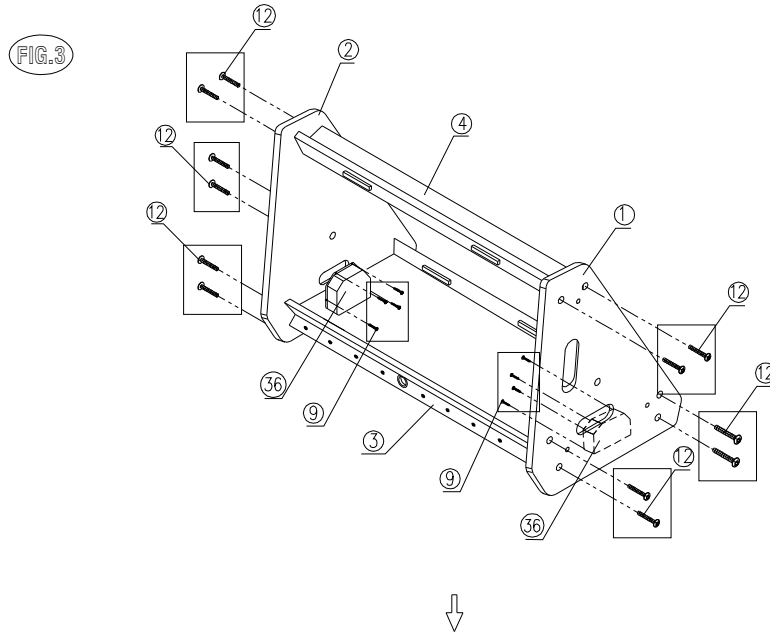

FIG.4.

- 8) Place Copper Caps (#45) in the hole of End Aprons as shown in FIG.4.
- 9) Attach Steel Legs (#6) to End Aprons using one of Leg Bolts (#7), two of Washers (#13), one of Leg Bolts (#39) per Leg as shown in FIG.4.
- 10) Attach Steel Rods (#29) to Legs (#6) using two of Leg Bolts (#12) and two of washers (#14) per steel rod as shown in FIG.4

NOTE: If it doesn't rotate smoothly, check to be sure you have not overtighten any bolts.

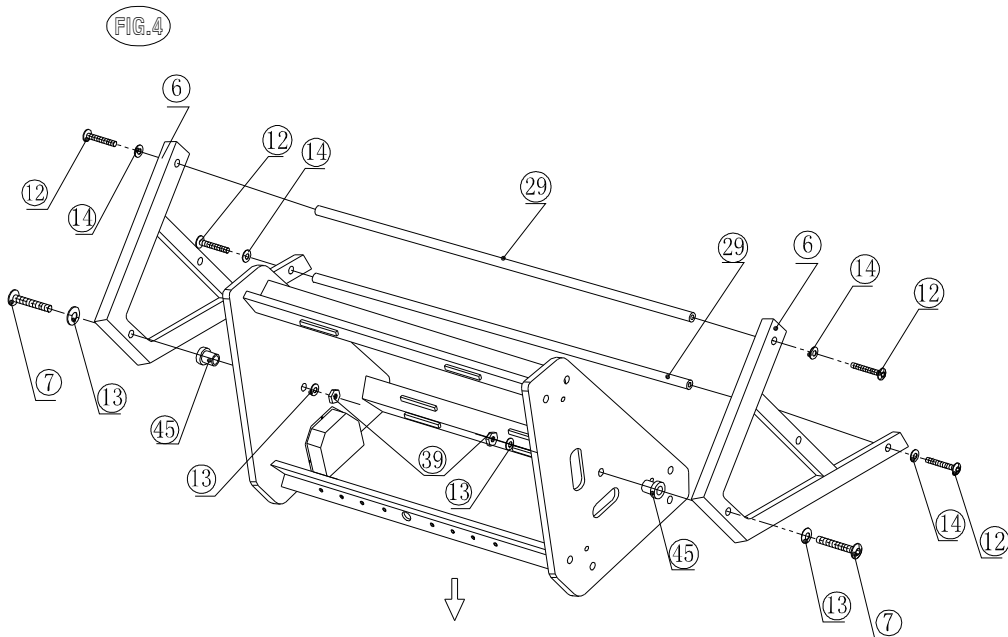

FIG.5.

- 11) Lift table assembly with two strong adults and set on its legs in the location where you will play.
 - 12) Attach Steel Legs (#6) to End Aprons using one of Wing Bolts (#44) per leg.
 - 13) Attach Goal Box (#36) to End Apron using four of Washer Head Screws (#9).
 - 14) Attach Hockey Playfield (#37) to Side Aprons using four of Washer Head Screws (#8). See FIG.5
 - 15) Attach scorers (#43) to Hockey Playfield (#37).
 - 16) Put Power-Line through the end apron as shown in FIG.5. Attach Hockey Playfield (#37) and two of Washer Head Screws (#8) on each side apron.
- NOTE: When you rotate table to other games,be sure to put the power - line to goal box and loosen wing bolts.

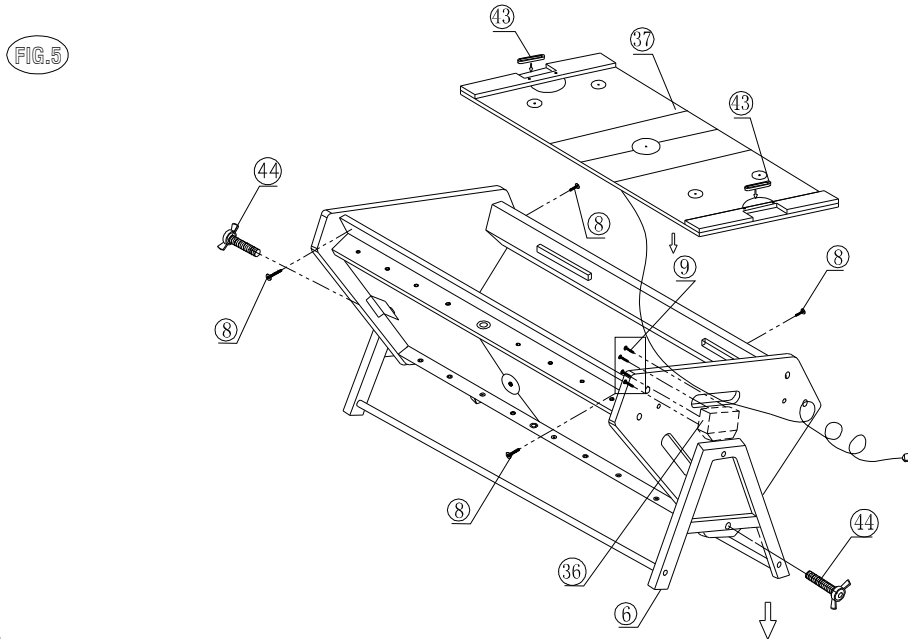

FIG.6.

- 17) Loosen Wing Bolts (#44) and rotate table to the same as FIG.6.
- 18) Tighten Wing Bolts (#44).Attach Billiard Playfield (#30) to Side Aprons using four of washer Head Screws (#8).

NOTE: If you want to play other games,be sure to loosen wing bolts.

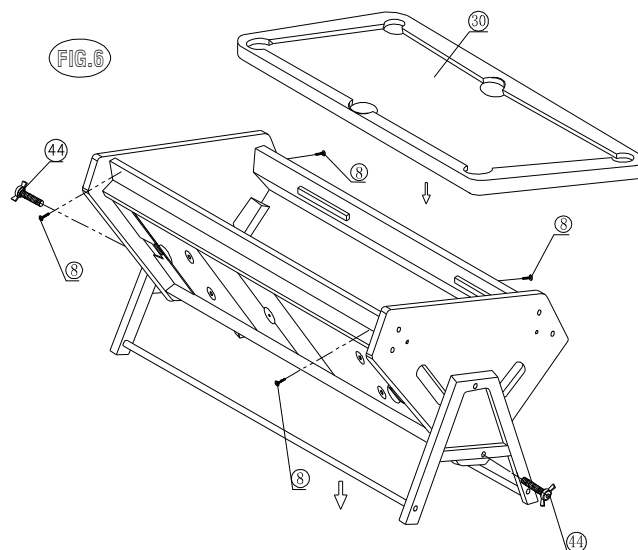

FIG.7.

- 19) Loosen Wing Bolts (#44) and rotate table to the same as FIG.7.
- 20) Tighten Wing Bolts (#44). Attach Playfield Caps (#46) at the corner of Playfield using two of Flat Head Screws (#15) per corner .See FIG.7.
- 21) Attach Scorers (#43) to Goal End Boards (#35).

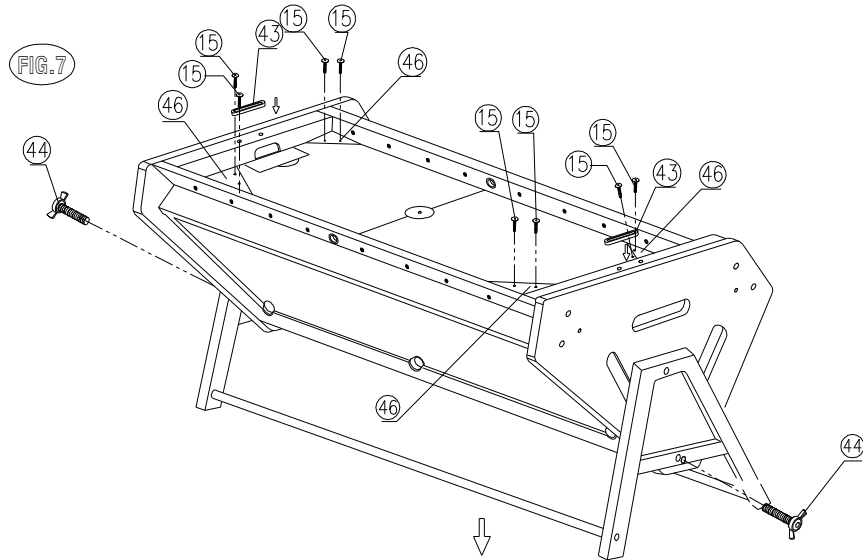

FIG.8.

- 22) Put Washers (#14) on the ends of inner Player Rods. Slide the Player Rods (#16 through #23) through the Player Rod Bushing .Attach Player Rod Bolts (#11) and Washers (#14) on the ends of inner rods.
- 23) Put Hand Grips (#25) on the outer Player Rods in order.
- 24) Put Stop Clips (#38) on player rods as shown in FIG.8-1 and FIG.8-2.

NOTE: When play soccer game,you should remove all stop clips.If play other games ,you should put all stop clips on the player rods again.Then loosen the Wing Bolts(#44) and rotate table.

