

Owners Manual

Table Soccer

Model#900324

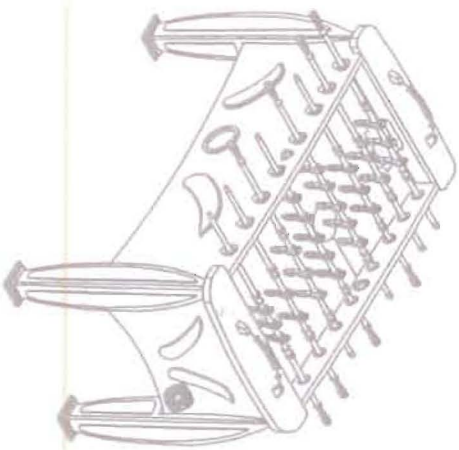

Assembly Instructions

Parts List

FIG. 7

18) Lift the table assembly from the floor with two strong adults. Turn it over and set table on its legs in the location where you will play. Go back and make sure that all connections are tight!



FIG. 7

(Bass)Just decorations

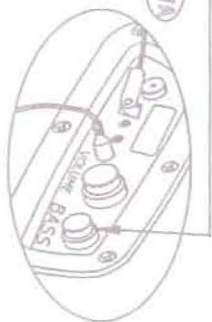

CAUTION: Two strong adults are recommended to flip the table as shown:
 1) Grab the table on the ground.
 2) Turn the table over.
 3) Place it on all four feet at the same time on the ground.

FIG. 8

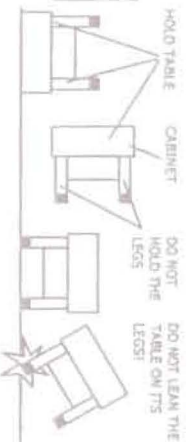

- 19) Attach the two Ball Entry Cups (# 24) to Side Aprons using one of Flat Head Screw (# 14) per Ball Return Cup. See FIG. 8.
- 20) Put the Hand Grips (#29) and End Caps (#30) on the player rods in order. NOTE: To make the Handles easier to attach, spray a little window cleaner on the rod ends prior to installation and tap on gently with a Hammer. See FIG. 8.
- 21) Attach the two Scoopers (#28) to the Goal End Boards (#2) using two of Flat Head Screws (#15) per Scooper. See FIG. 8.

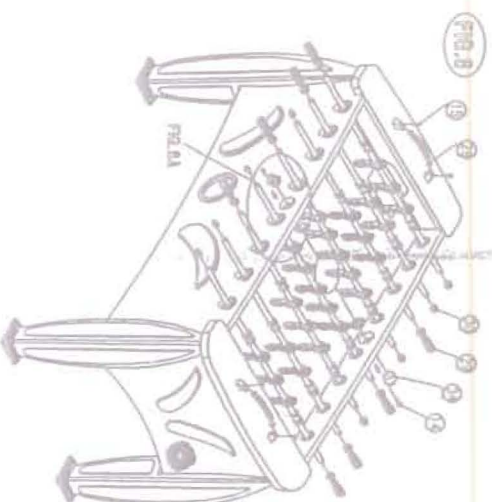
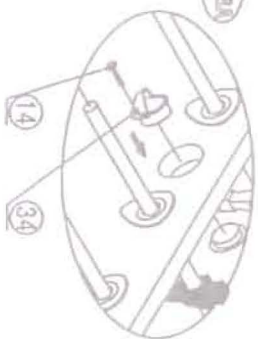

FIG. 8A



We recommend that two adults work together to assemble this game.

ASSEMBLY INSTRUCTIONS:

- 1) Open the carton of your new table game near where you will play. Select a clear level floor. The game requires at least two adults to assemble the table.
- 2) Remove all the contents from inside the carton and verify that you have all listed parts as shown on the Parts List. NOTE: The player rods are pre-assembled. We suggest that you use the bottom carton as a clean, flat working area to protect the game. Carefully cut or tear the four carton corners so that the bottom carton is now your work area. FIG. 1.
- 3) Place one Side Apron (# 1) with scooped side facing inward and the finished edge facing down. Slide the Player Rods (#19 through #24, #28, #30) through the Player Rod Bushing in the order shown in FIG. 1. NOTE: Make sure that the player rods are installed properly. The players for each team must be facing the same direction.
- 4) Now slide the other Side Apron (#2) over the other ends of the Player Rods with the scooped side facing inward.

FIG. 1

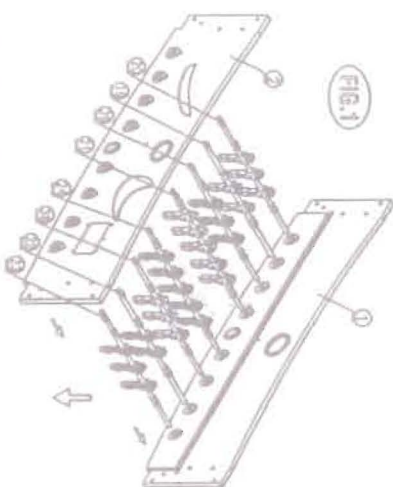

FIG. 2

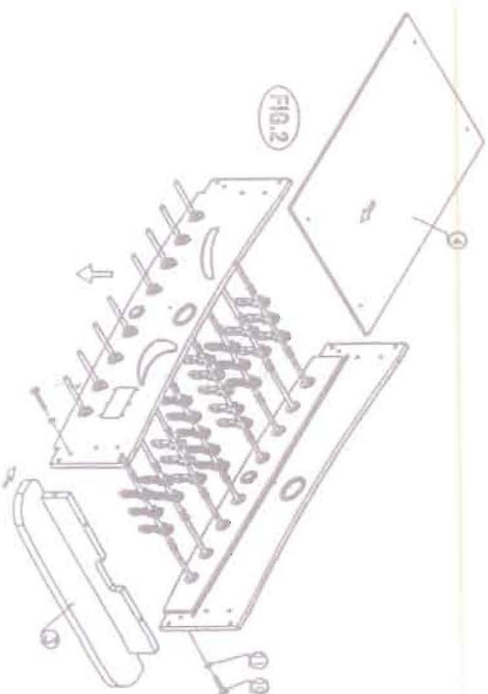

FIG. 2

- 5) Attach one Goal End Board (#3) with the Goal Box facing inward between the Side Aprons (# 1 & #2). Secure with two Bolts (#10) and two of Washers (#11), across them through the Side Apron into the Goal End Board. NOTE: Leave some space - Do not tighten screws securely at this time.
- 6) Locate the Playfield (#4) and slide the Playfield with the graphics facing down as shown in FIG. 2. NOTE: If the field does not slide smoothly, check to be sure you have not over tightened any screws or the playfield is not caught by the slot.

FIG. 3.

Repeat this step to attach the other Goal End Board (#3) to Side Apron (#1 & #2). Center the playfield between the two goal end boards, and make sure that the playfield is in the grooves of side aprons and goal end boards. NOTE: Be sure that two side aprons and goal end boards are square. Now go back and tighten all the connections.

- 9) For the Soccer Playfield (#4) using four of Washer-Head Screw (#16) as shown in FIG. 3.
- 1) Attach the two End Aprons (#8) to the two Side Aprons using four of Washer-Head Screws (#16) per Side. See FIG. 3.
- 8) Place the two Support Braces (#7) on the Playfield (#4) as shown in FIG. 3. Attach them using one of White Bolt (#10) and one of White Washer (#11) per Side. See FIG. 3.

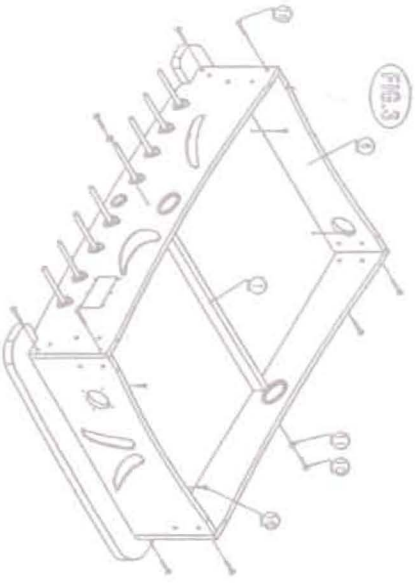

FIG. 4.

- 7) Attach the two four legs (#9) to the cabinet using four of Leg Bolts (#8) and four of Washers (#9) per Leg. See FIG. 4.
- 5) Attach the two Goal Boxes (#25) to the Side Aprons using four of Washer-Head Screws (#13) per Goal Box.
- 6) Attach the two Ball Return Trays (#27) to the End Aprons using two of Washer-Head Screws (#13) per Ball Return Tray.
- 3) Connect the Goal Boxes (#25) with Ball Return Trays (#27) using two of Ripple Tubes (#29) as shown in FIG. 4.

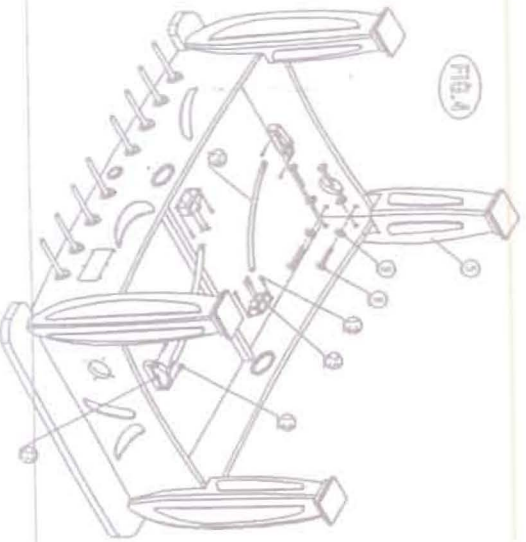

FIG. 5.

15) Attach the one Controller (#32) to the Side Apron using six of Flat Head Screws (#18). See FIG. 5 and 5A.

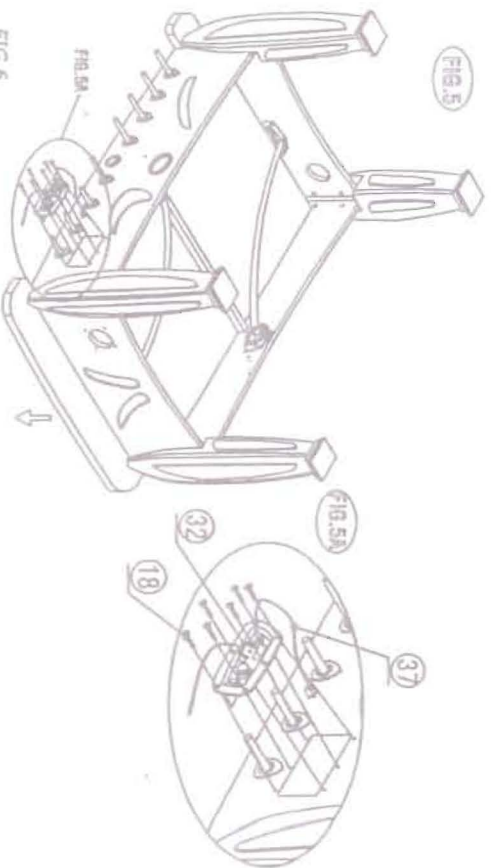
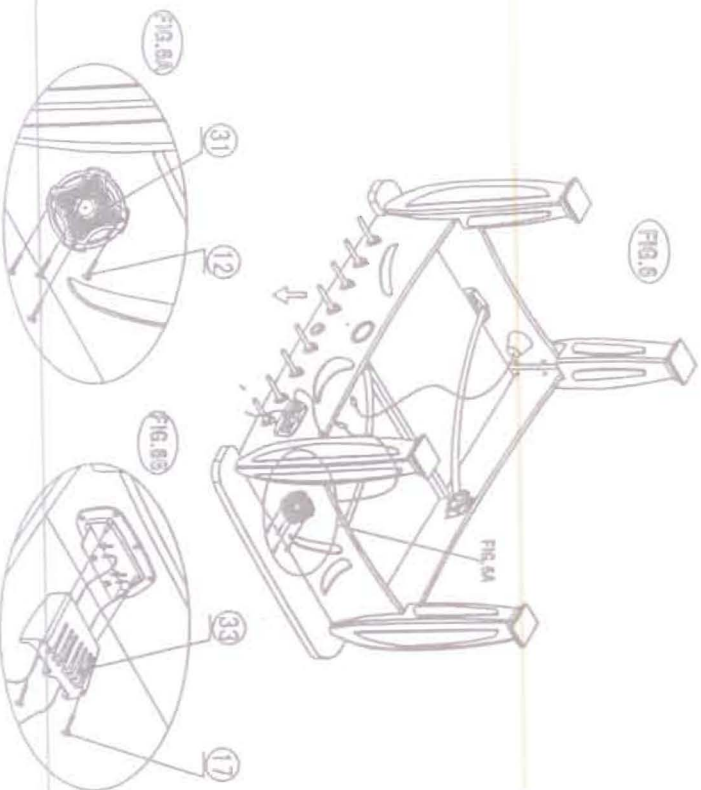

FIG. 6.

- 16) Attach the two Loudspeakers (#31) to the Side Apron using four of Round Head Screws (#12) per Loudspeaker. See FIG. 5 and 6A.
- 17) Attach the one cover (#33) to the Controller using two of Round Head Screws (#17). See FIG. 6B.













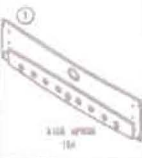

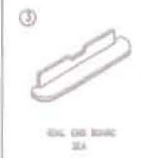

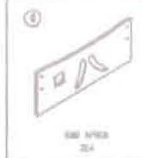













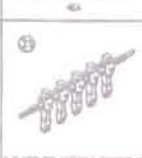



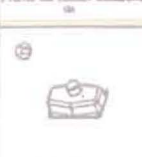
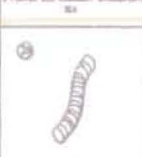
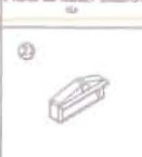

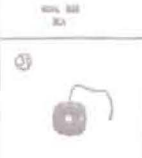
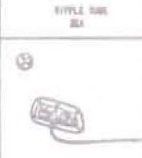
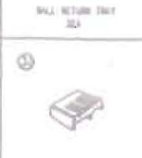
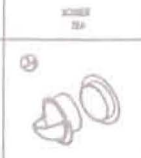
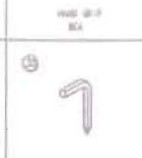
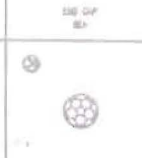
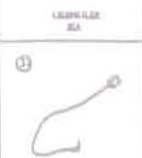

WARNING: Choking Hazard—Toy contains small balls and/or small parts. Not for children under 3 years.

IMPORTANT!

Please Keep Your Instructions. Before attempting assembly, please read through this instruction book to familiarize yourself with all the parts and assembly steps. We recommend that two adults assemble this game. Please refer to the Parts List below and be sure that all parts have been included.

PARTS LIST

 1x16 WHITE 16A	 1x16 WHITE 16A	 1x16 WHITE 16A	 1x16 WHITE 16A	 1x16 WHITE 16A	 1x16 WHITE 16A
 SUPPORT BRACE 16A	 1x16 WHITE 16A	 1x16 WHITE 16A	 1x16 WHITE 16A	 1x16 WHITE 16A	 1x16 WHITE 16A
 1x16 WHITE 16A	 1x16 WHITE 16A	 1x16 WHITE 16A	 1x16 WHITE 16A	 1x16 WHITE 16A	 1x16 WHITE 16A
 1x16 WHITE 16A	 1x16 WHITE 16A	 1x16 WHITE 16A	 1x16 WHITE 16A	 1x16 WHITE 16A	 1x16 WHITE 16A
 1x16 WHITE 16A	 1x16 WHITE 16A	 1x16 WHITE 16A	 1x16 WHITE 16A	 1x16 WHITE 16A	 1x16 WHITE 16A
 1x16 WHITE 16A	 1x16 WHITE 16A	 1x16 WHITE 16A	 1x16 WHITE 16A	 1x16 WHITE 16A	 1x16 WHITE 16A
 1x16 WHITE 16A	 1x16 WHITE 16A	 1x16 WHITE 16A	 1x16 WHITE 16A	 1x16 WHITE 16A	 1x16 WHITE 16A
 1x16 WHITE 16A	 1x16 WHITE 16A	 1x16 WHITE 16A			